

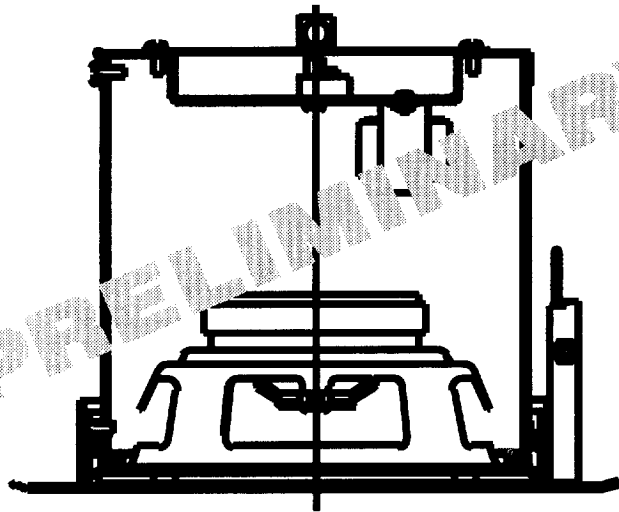

a MARK IV company



EP 6.5 SERIES

Duplex® Ceiling Loudspeaker Systems

- Quick and easy to install
- Architecturally pleasing
- High SPL capability
- Multiple transformer taps
- System ships complete from factory

Description

The Altec Lansing EP 6.5 Series Duplex® loudspeaker systems are complete two-way ceiling loudspeaker packages. The package consists of a spring / bezel assembly, grille, rear enclosure, 6.5-inch Duplex® loudspeaker and line matching transformer. The loudspeakers feature 6.5-inch low-frequency cones and high-temperature voice-coil assemblies coaxially mounted with wide-dispersion neodymium tweeters. The dual magnet construction allows each speaker to be structurally, magnetically, electrically and mechanically independent of the other. The 407-8A loudspeaker utilizes a crossover network, centered at 3,000 Hz, that provides 6-dB-per-octave tweeter protection outside of its operating range.

The EP407-8T utilizes a transformer that offers a selection of 1, 2, 4 and 8 watt delivered to the loudspeaker system using either 70 V or 100 V lines.

The EP407-16T utilizes a transformer that offers a selection of 2, 4, 8 and 16 watt delivered to the loudspeaker system using either 70 V or 100 V lines.

The bezel and perforated grille are finished in semi-gloss white powder coated enamel. The rear enclosure is constructed from Zinc plated cold-rolled steel.

The rear enclosure provides an optimum internal volume ensuring extended low-frequency performance. It is constructed from heavy-gauge, rugged cold-rolled steel, under-coated to prevent panel resonance, and finished with rust-inhibiting zinc plating. In addition the interior is lined with a glass wool blanket to ensure optimum acoustic performance. A rear cover, with provisions for a junction box fitting, provides access an 8-pin terminal block that allows direct connection to each of the transformer taps.

An optional tile bridge system is available for safe suspension of the EP 6.5 Series ceiling systems in a drop ceiling that uses mineral wool, or other fiber based, ceiling tiles. These components have been designed to work together as a complete system in a wide range of different ceiling constructions. They provide wide dispersion, high-efficiency, high-maximum output, ease of installation, and wide range reproduction of music or voice.

Mounting the System in a Ceiling

Using the T-bar Support Accessories

The Altec Lansing EP Series ceiling speaker systems have been designed to accommodate a wide range of ceiling tile and structural ceiling materials. The spring assemblies can accommodate a range of material thicknesses from .375-inch up to 1.25-inch thick.

Before beginning the installation determine the type of material employed in the ceiling. For all "soft" ceiling tiles it is imperative that the optional CTB ceiling tile bridge be utilized. The support rails are 603 mm (23-3/4 in.) long and will support a loudspeaker system in a 2 ft x 4 ft (or 2 ft x 2 ft) tile. In addition, if angled at 10 to 15 degrees the tile bridge can be used with 600 mm tiles (see Figure A).

Figure A

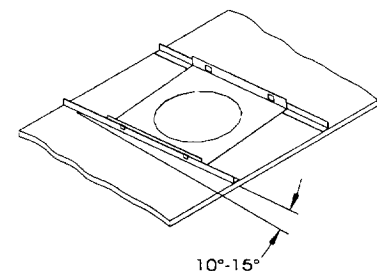

Ceilings constructed from particle board, gypsum board or plaster do not normally require the use of a tile bridge.

Preparing the Wires

The ceiling system is provided with an eight-way barrier strip that provides access to each transformer tap. Up to #10 gauge wire can be used and a choice of both screw terminal or spring loaded push terminals have been provided (see Figure B). The re-

ALTEC LANSING EP 6.5 SERIES DUPLEX CEILING LOUDSPEAKER SYSTEMS

ALTEC LANSING EP 6.5 SERIES

ommended strip length is 6.4 mm to 8.0 mm (.250 in to .312 in).

Using Conduit Fittings

The rear cover has provisions for use of a junction box, or gland nut, style fitting (see Figure E). This allows both solid or flexible conduit to be connected directly to the system. If local codes require the use of conduit ensure that it is well supported. Too much unsupported weight may prevent the ceiling system from closing flush against the ceiling surface.

Selecting a Transformer Tap

The transformer tap of choice can be obtained by making connection between the ground terminal (#1) and any of the wattage taps indicated on the input label (#5, 6, 7 or 8). Either 70 V or 100 V lines can be used - refer to the input panel label to determine the appropriate wattage for the line voltage used (see Figure B).

Figure B

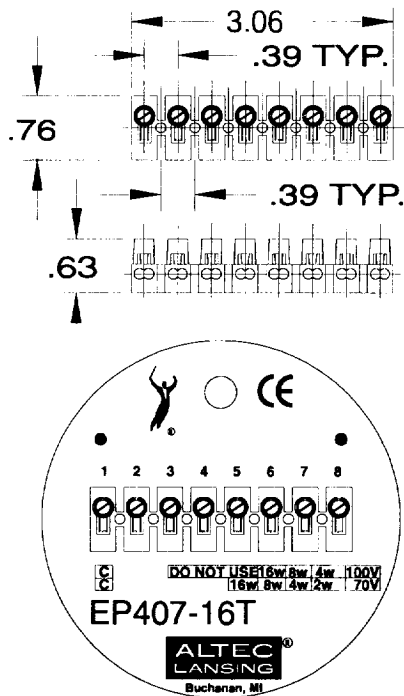

Cutting Mounting Holes

- The hole for the 4-inch systems should be 151 mm (5.95-in.) (See Figure C.)
- The hole for the 6.5-inch systems should be 184 mm (7.25-in.)
- The hole for the 8-inch systems should be 222 mm (8.75-in.)

Note: The CTB-Series of tile support bridges provide a perfect hole template and will center the hole on the width of the tile.

Figure C

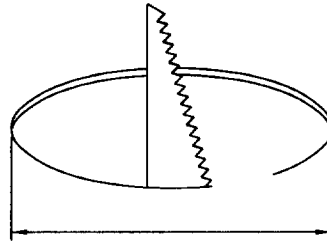

Check for electrical conduit / wiring and other hazards before cutting the hole. In addition allow sufficient clearance for both the depth of the loudspeaker / enclosure and any electrical fittings used.

Installation

T-bar support

The T-bar system is comprised of two support bars and a support bridge. The bars are inserted through tabs formed in the two sides of the bridge and can be adjusted to allow the cut out to be positioned at any point on the width of a ceiling tile. Additionally the tile bridge system can be moved along the drop ceiling support rails and positioned at any point along the length of a ceiling tile. The ceiling bridge should be positioned directly above the hole cut in the ceiling tile with the bridge resting directly against the rear of the tile.

Bezel / Spring Assembly

The bezel / spring assembly is installed from the "room side" by pushing the inner tubular section up through the hole cut in the ceiling tile. If a tile bridge is used the bezel inner tube will also pass through the hole in the tile bridge. The top leg of the clamp springs ([3] for the 4-inch and 6.5-inch systems

and [4] for the 8-inch system) should be released, one at a time, by reaching through the hole. Ensure that the metal arms are seated firmly, and evenly, on the ceiling tile or ceiling tile / bridge combination (see Figure D). Then push the bottom leg of the clamp spring up through the slot in the spring bracket pushing slightly counter clockwise to lock in position. This keeps constant pressure on the spring leg.

Figure E

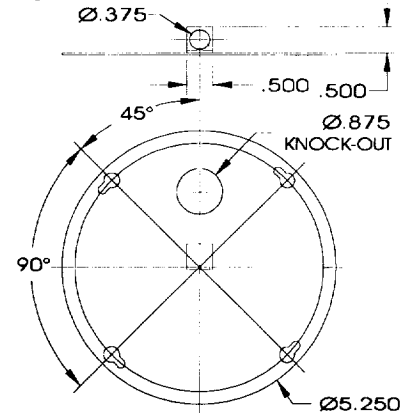

Loudspeaker System Assembly

Before installing the ceiling loudspeaker system it is necessary to pull the hook up wire downwards through the hole in the ceiling and make electrical connection to the terminal block on the rear cover as previously discussed. If required by local regulations a mounting point is provided on the rear cover that can be used for the attachment of a safety chain, or wire. (See Figure B).

In the case of the Altec Lansing EP Series of ceiling loudspeaker systems the grille / loudspeaker system can be installed by pushing this assembly through the central opening of the bezel assembly and then rotating the grille / loudspeaker until the "pins" on this item align with the "bayonet" slots

Figure D

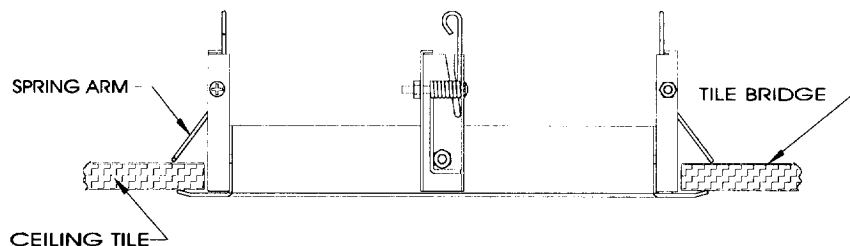

ALTEC LANSING EP 6.5 SERIES DUPLEX® CEILING LOUDSPEAKER SYSTEMS

on the bezel assembly (see Figure F).

Removing a Loudspeaker System Assembly

A loudspeaker system can be removed by pushing upwards on the grille and rotating the grille / loudspeaker combination until

Figure F

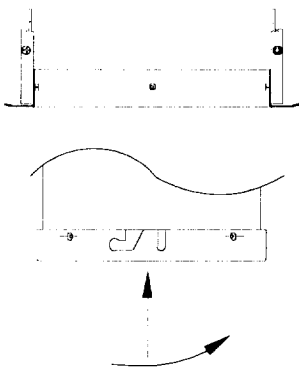

the pins on the grille escape the bayonet slots on the bezel assembly (see Figure F). Disconnect the safety chain or cable (if employed) and disconnect the electrical connection.

Painting Loudspeaker Assemblies

Bezels

The bezels may be painted before or after installation. Use conventional spray or roller equipment to paint the loudspeaker bezel when the rest of the ceiling is painted. Latex and oil based paints will adhere easily to the loudspeaker bezel, but can scratch if handled carelessly.

Figure G

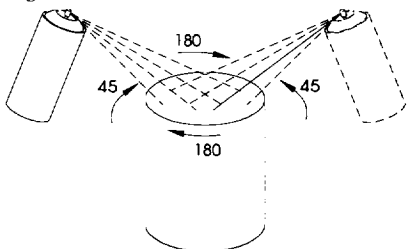

Grille / Loudspeaker Assemblies

Brushes or rollers may clog the grilles, interfering with the acoustic performance of the ceiling system. Additionally a high-pressure spray system may penetrate through the cloth barrier coming into contact, and damaging, the paper cone. Instead, spray paint the grilles with lacquer

or enamel paint in aerosol cans. (A professional, siphon feed spray gun may be used provided the pressure is sufficiently low to prevent cone damage). Place the grille / loudspeaker system on a flat surface facing upwards. Clean the grilles first to remove all possible contaminants. Apply the paint at a 45 degree angle to the grille surface (see Figure G). Rotate the grille 180 degrees and apply a second coat of paint. Alternatively the grille can be removed from the loudspeaker enclosure by the removal of three self tapping screws in the vertical section of the grille (see Figure F).

Safety Regulations

All Altec Lansing EP Series of ceiling loudspeaker systems are designed to meet the following standards [approval pending]:

- UL 1480 (general purpose category)
- UL 2043 (ceiling plenums)
- NFPA 70 NEC 1993 Article 300-22 (C) and UL 2043; NFPA 90A-1993 [Installation of air-conditioning and ventilation systems, section 2-3.10.1 (a) exception 2.]

Packaging

Please note that all Altec Lansing EP Series ceiling loudspeaker systems are packaged and sold in quantities of (6). In addition the systems are delivered in two containers - pack 1 of 2 which contains (6) grille / loudspeaker assemblies and pack 2 of 2 which contains (6) bezel assemblies. This arrangement allows the sound contractor to deliver the bezel (pack 2 of 2) to the construction site earlier for installation by a subcontractor (when appropriate). Pack 1 of 2 can be retained (locked in a secure part of construction site or on the sound contractors premises) until the completion date when the sound contractor can complete the installation.

Architect's and Engineer's Specifications

EP407-8T/EP407-16T Duplex® Ceiling Loudspeaker Systems

The loudspeaker systems shall comprise of a spring / bezel assembly, front grille, rear enclosure, transformer and 6.5-inch Duplex® type loudspeaker. The loudspeaker will feature a 6.5-inch low-frequency cone and a

high-temperature voice coil assembly coaxially mounted with a wide dispersion neodymium tweeter. The Duplex® loudspeaker shall meet the following criteria. AES power rating shall be 16 watts of band limited pink noise (95 Hz to 18 kHz, 6 dB crest factor). Frequency response, uniform from 95 Hz to 18 kHz. Pressure sensitivity, 93 dB SPL at 1 meter (94 dB at 4 feet) on axis with one watt of band-limited pink noise from 500 Hz to 3 kHz (ref. 20 uPa). Minimum impedance, 6.0 ohms. The loudspeaker shall be 23.5 cm (9.24 in.) in diameter and 18.5 cm (7.27 in.) deep. Weight shall be 2.5 kg (5.5 lbs) [EP407-8T] and 3.0 kg (6.5 lbs) [EP407-16T]. The Duplex® ceiling loudspeakers packages shall be the Altec Lansing models EP 407-8T with 8 watt transformer; and EP407-16T with 16 watt transformer.

Warranty (Limited)

Altec Lansing products are guaranteed against malfunction due to defects in materials or workmanship for a specified period, as noted in the individual product-line statement(s) below, or in the individual product data sheet or owner's manual, beginning with the date of original purchase. If such malfunction occurs during the specified period, the product will be repaired or replaced (at our option) without charge. The product will be returned to the customer prepaid.

Exclusions and Limitations: The Limited Warranty does not apply to: (a) exterior finish or appearance; (b) certain specific items described in the individual product-line statement(s) below, or in the individual product data sheet or owner's manual; (c) malfunction resulting from use or operation of the product other than as specified in the product data sheet or owner's manual; (d) malfunction resulting from misuse or abuse of the product; or (e) malfunction occurring at any time after repairs have been made to the product by anyone other than Mark IV Audio Service or any of its authorized service representatives.

Obtaining Warranty Service: To obtain warranty service, a customer must deliver the product, prepaid, to Mark IV Audio Service or any of its authorized service representatives together with proof of purchase of the product in the form of a bill of sale or

ALTEC LANSING EP 6.5 SERIES DUPLEX CEILING LOUDSPEAKER SYSTEMS

ALTEC LANSING EP 6.5 SERIES

received invoice. A list of authorized service representatives is available from Mark IV Audio Service at 10500 W. Reno Avenue, Oklahoma City, OK 73127 (800/845-8727 or FAX 405/577-3274).

Incidental and Consequential Damages

Excluded: Product repair or replacement and return to the customer are the only remedies provided to the customer. Altec Lansing shall not be liable for any incidental or consequential damages including, without limitation, injury to persons or property or loss of use. Some states do not allow the exclusion or limitation of in-

cidental or consequential damages so the above limitation or exclusion may not apply to you.

Other Rights: This warranty gives you specific legal rights, and you may also have other rights which vary from state to state.

Altec Lansing Speakers and Speaker Systems are guaranteed against malfunction due to defects in materials or workmanship for a period of five (5) years from the date of original purchase. The Limited Warranty does not apply to burned voice coils or malfunctions such as cone and/or coil damage re-

sulting from improperly designed enclosures. Altec Lansing active electronics associated with the speaker systems are guaranteed for three (3) years from the date of original purchase. Additional details are included in the Uniform Limited Warranty statement.

Altec Lansing Accessories are guaranteed against malfunction due to defects in materials or workmanship for a period of one (1) year from the date of original purchase. Additional details are included in the Uniform Limited Warranty statement.

Figure 1—Polar Response

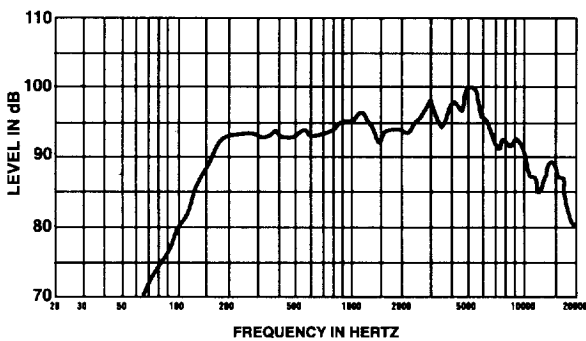
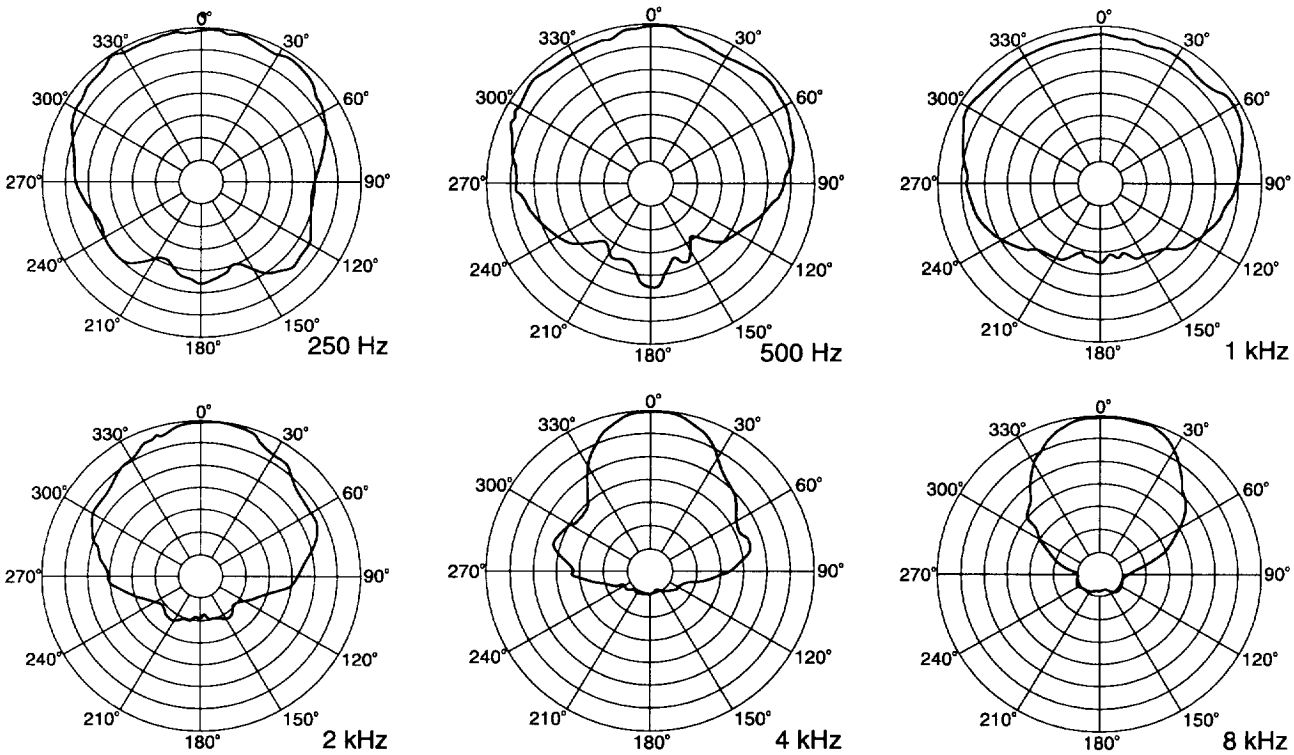

Figure 2 Frequency

Note 1

Pink noise signal, one Watt calculated using E^2/Z_{min} , 3.16 meter measurement distance referred to one meter.

ALTEC LANSING EP 6.5 SERIES DUPLEX CEILING LOUDSPEAKER SYSTEMS

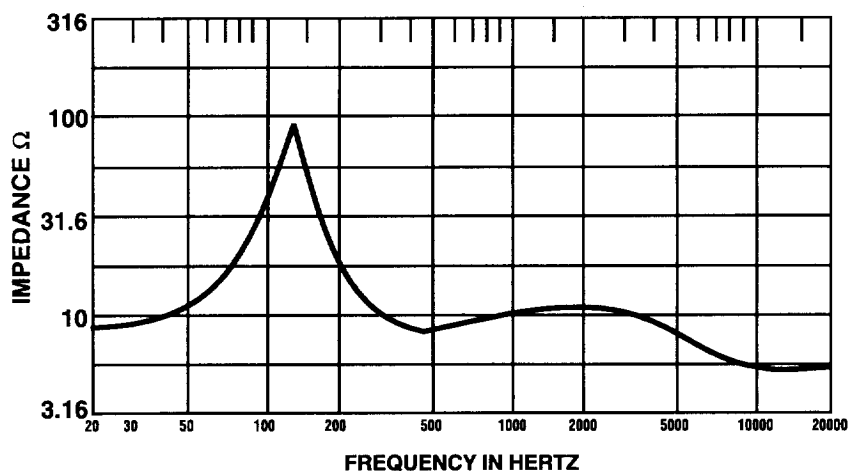

Figure 3 Impedance

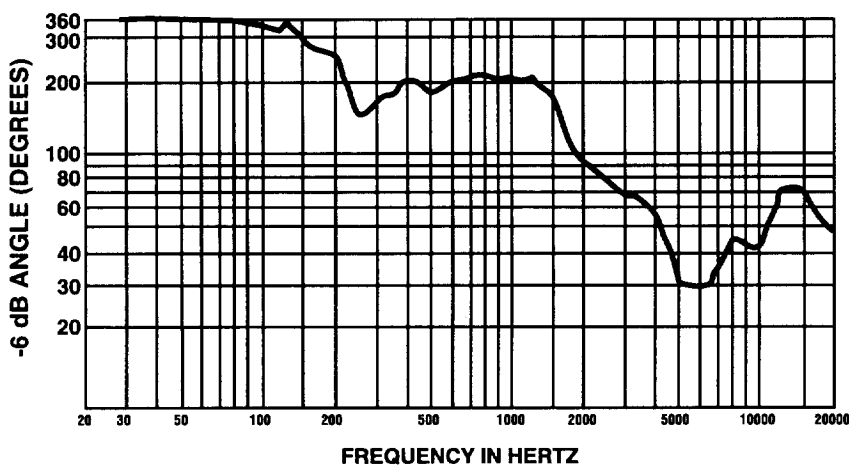

Figure 4 Beamwidth

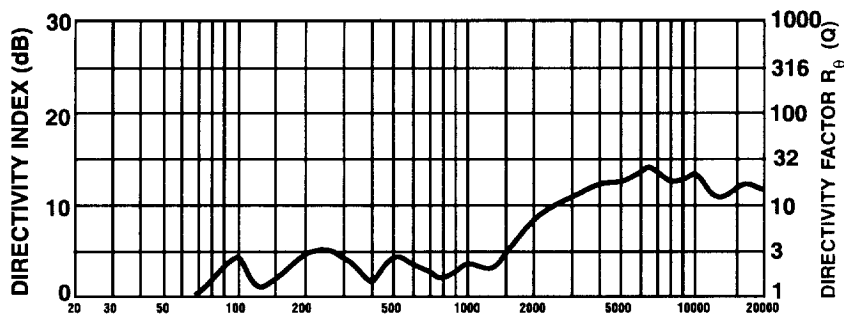

Figure 5 Directivity

Note 2

The directional response was measured in an anechoic environment at a distance of 6.1 meters (20 feet) using 1/3-octave filtered pink noise.

Note 3

This system rating patterned after the EIA RS-426-A 1980 method where the test signal is pink noise with a 6-dB crest factor over the bandwidth of the system, with power calculated using $E^2/Re \times 1.15$, for 24 hours.

Note 4

This measurement made under the same conditions as pressure sensitivity, but at rated power, and takes into account any power compression effects due to nonlinearities in the system.

ALTEC LANSING EP 6.5 SERIES DUPLEX CEILING LOUDSPEAKER SYSTEMS

Figure 6

ALTEC LANSING EP 6.5 SERIES

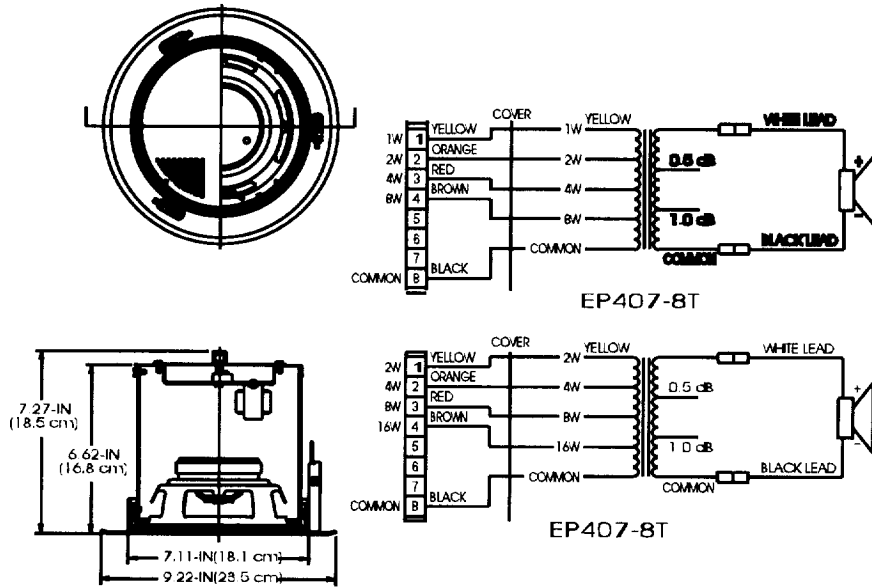

Specifications

System Type:

Two-way, full range, Duplex® loudspeaker system.

Pressure sensitivity (1 W, 500 Hz - 3 kHz, re: 20 uPa, see Note 1):

93 dB SPL

Frequency Response (see Figure 1, Note 2):

95 Hz - 18 kHz

Power Handling (95 Hz - 18 kHz, AES method, see Note 3):

16 watts, Maximum Long Term

Output (16 watts input, 1 m, re: 20 uPa, see Note 4):

105 dB SPL

Impedance,

Nominal:

8.0 ohms

Minimum at 15 kHz:

5.0 ohms

Components:

6.5 inch, high-efficiency, low-frequency driver with a coaxially-mounted, 2.0-inch cone neodymium tweeter.

Crossover Network:

3,000 Hz with 6 dB per octave tweeter protection.

Input Terminals:

Eight-way barrier strip with screw, or push type, connectors that will accept up to two #10 AWG wires.

Accessories:

CTB-6.5 Ceiling Tile Bridge.

Dimensions:

Loudspeaker diameter:

23.5 cm (9.24 in)

Depth:

18.5 cm (7.27 in)

Net Weight,

EP407-8T:

2.2 kg (5.5 lbs)

EP407-16T:

2.6 kg (6.5 lbs)

Shipping Weight,

EP407-8T:

2.7 kg (6.0 lbs)

EP407-16T:

3.2 kg (7.0 lbs)

Finish:

White powder-coated enamel.

Transformer Specifications

Frequency Response:

65 to 15,000 Hz, +/-3 dB

Insertion Loss:

1.25 dB

Secondary Impedance:

8 ohms

Primary Impedances and Power Drawn for 407-8T & 407-16T:

	15708E	15716E
	5,000 ohms	2,500 ohms
	1.0 watts	2.0 watts
	2,500 ohms	1,250 ohms
	2.0 watts	4.0 watts
	1,250 ohms	625 ohms
	4.0 watts	8.0 watts
	625 ohms	312 ohms
	8.0 watts	16.0 watts

Connection Type:

Eight-way barrier strip that will accept (2) #10 Guage wires.



a MARK IV company

600 Ceceil Street, Buchanan, MI 49107
800/234-6831, 616/695-683, Fax 616/695-1304

© 1996 ALTEC LANSING CORPORATION

Part # 42-02-051395